



Published by **PUMPA**
Registered Charity No 1019792
Purine Research Unit
St Thomas' Hospital
London
SE1 7EH
www.pumpa.org.uk

Caring for Patients
with
**ADENOSINE
DEAMINASE
(ADA) DEFICIENCY**



PUMPA

A Guide for Patients, Parents and Professionals

Introduction

The objective of this booklet is to provide patients, parents and professionals with the basic facts about the purine disorder adenosine deaminase (ADA) deficiency in a simple and understandable fashion - its clinical presentation, biochemistry and progression, and particularly what treatments are available. To this end we have drawn on the experience of those involved at every level in Britain. Clinically ADA deficiency presents as severe combined immunodeficiency (SCID) - which in layman's language means inability to fight any infections. Importantly, if unrecognized and untreated, severe deficiency of ADA results in death within the first months of life. It is a devastating disorder. Fortunately, today ADA deficiency, when diagnosed sufficiently early, is also a treatable disorder.

This book forms part of a series aimed at covering signs, symptoms and treatments for disorders under the PUMPA umbrella and will fill a much-needed gap. Like the first publication on Lesch-Nyhan Disease (LND), and the two others which followed - familial juvenile gout (FJHN) and adenine phosphoribosyltransferase (APRT) deficiency - ADA deficiency has been the subject of annual PUMPA Seminars at Guy's Hospital, London. This book follows the Seminar in November 2005, which reports advances in diagnosis and importantly, progress in treating ADA deficiency – the first disorder under the PUMPA umbrella to be treated successfully, initially by bone marrow transplantation, and now **gene therapy** - the **first** such patient in **Britain**.

This booklet summarises the experience of patients and parents, and reports how diagnosis of ADA deficiency in families has enabled treatment that has changed their lives. Since ADA deficiency can lead to total inability to combat infection, and early death if not recognized and treated, it is particularly important that clinicians are aware of this disorder as a potential cause of life-threatening infections in a baby, or young child - even young adults.

The publishers wish to acknowledge the valuable contribution to the booklet from:
Professor J Stewart Cameron, Emeritus Professor of Renal Medicine*

Dr Bobby Gaspar, Senior Lecturer, Consultant in Paediatric Immunology, Great Ormond Street Hospital NHS Trust, London

Dr David Webster, Royal Free Hospital, London

Dr Lynette Fairbanks, Principal Biochemist *

Dr Bridget Bax, Senior Research Fellow, Clinical Development Sciences St. George's, University of London

Dr Tony Marinaki, Principal Biochemist *

Dr Anne Simmonds, Emeritus Senior Lecturer*

Leslie and Peter Wilkinson, Patient family

* Renal or Purine Research Units, Guy's and St Thomas' Hospitals, London

Notes

The publishers, authors and printers cannot accept liability for errors or omissions.
No part of this publication may be reproduced in any form without the written permission of the copyright holder and the publisher, application for which should be made to the publisher.

(c) Copyright PUMPA, The Purine Metabolic Patient's Association, 2005.

Reprinted September 2008.

Designed and Typeset by E.H. Graphics, East Sussex (01273) 515527

Printed by Tansleys, East Sussex (01323) 891019

Contents

INTRODUCTION: LIVING WITH ADA, THE PARENTS' VIEW <i>Lesley and Peter Wilkinson</i>	4
SCID AND ADA DEFICIENCY - HOW DO THEY COME TO ATTENTION AND HOW DO THEY RELATE?	6
<i>Professor Stewart Cameron</i>	
WHAT EXACTLY IS ADA?	9
<i>Professor Stewart Cameron</i>	
WHY IS ADA SO IMPORTANT?	13
<i>Dr Anne Simmonds</i>	
HOW DO WE DIAGNOSE DEFICIENCY OF ADA?	17
<i>Dr Lynette Fairbanks</i>	
ADA DEFICIENCY - MOLECULAR DIAGNOSIS	19
<i>Dr Tony Marinaki</i>	
ADVANCES IN TREATING ADA DEFICIENT PATIENTS, INCLUDING GENE THERAPY	22
<i>Dr Bobby Gaspar</i>	
ADA IS NOT ALWAYS A DISEASE OF CHILDHOOD - AN UNUSUAL VARIANT OF ADA IN ADULTS	25
<i>Dr David Webster</i>	
ALTERNATIVES TO BONE MARROW TRANSPLANTATION	27
<i>Dr Bridget Bax</i>	
LONG TERM TREATMENT WITH ERYTHROCYTE ENCAPSULATED ADA. A PATIENT'S EXPERIENCE	30
<i>Gillian Lehane</i>	

Living with ADA

THE PARENTS VIEW

Lesley and Peter Wilkinson

Our first baby, a son, was constantly unwell. We became used to covering the carpet in the living room with towels when we fed him because he would vomit the food right across the room. Our GP referred us to several local specialists who could not help. After six months of referrals to further regional specialists, we were eventually told that we must take our child to Great Ormond Street Children's Hospital (GOS), in London. We were fearful. It must be dire!

Our son was found to have no white blood cells, which meant he had no defence against infection and he was placed in a plastic 'bubble' in a special ward at GOS. Eventually the cause of his life-threatening immunodeficiency (SCID) was diagnosed by the Purine Research Laboratory at Guy's. Our baby had been born with a complete



deficiency of the purine enzyme adenosine deaminase (ADA), a then 'new' purine disorder which the laboratory had identified for the first time in Britain in the baby above in 1972. (Figure 1).

Hopes raised by transplantation, but alas these were early days!

We were told that the only chance was bone marrow transplantation - then in its infancy. This meant that after the operation Lesley had to stay in a special room in the same sterile environment as the baby at GOS, with Peter commuting to London at weekends, which continued for almost a year. Sadly our son was one of the unlucky ones and did not survive. Having watched him suffer for many months we determined we would not wish this on further children & decided to wait until the Purine laboratory had developed methods for early prenatal diagnosis. Thankfully, they were eventually able to do this, but developing new procedures takes time, money and dedicated research and the Unit had no permanent funding. However, fortunately they managed to obtain a 3 year grant to develop the technique for



prenatal diagnosis of ADA deficiency in the first trimester and we decided to try again. Sadly the next two pregnancies were also affected, but since the test meant just a quick trip down the motorway and back in a day we decided to persevere. This team-work enabled the birth of a healthy baby boy (Figure 2). We

now have two healthy sons and cannot thank the Guy's Unit enough. Without them we would indeed have been **parents without children!**

*The disorder described so vividly by Lesley and Peter - Adenosine deaminase deficient severe combined immunodeficiency (SCID) - has become the second treatable disorder under the PUMPA umbrella, the first being APRT (as described in our previous booklet). Importantly, ADA is also the first PUMPA disorder to be treated successfully with bone marrow transplantation - and recently also by gene therapy - **the first in Britain** - as you will learn from Dr Gaspar and Dr Fairbanks.*

SCID and ADA Deficiency

HOW DO THEY COME TO ATTENTION AND HOW DO THEY RELATE?

J Stewart Cameron

Inherited deficiency of the enzyme ADA comes to attention in a variety of ways, but most commonly causes alarm in the very early period after birth, or in infancy: that is in children of up to 1-2 years of age. Some unfortunates have early overwhelming infections and do not survive. Other babies do not thrive or gain weight normally, are fretful and may have repeated attacks of diarrhoea and infections, particularly bronchitis or worsening problems with breathing from lung disease. Skin rashes may also be prominent.

These symptoms of course have many causes, most of them relatively benign. In contrast the conditions we are dealing with are very rare, so a delay in making the diagnosis is almost inevitable - unless the family already has experience from a previous child. However because of the inheritance pattern (outlined later) the parents and their own families (uncles and aunts etc. of the baby) themselves are almost always completely normal, which makes things more difficult.

At some point the baby will be referred by the local doctor to a paediatrician for further investigation. This may be prompted by the finding that the infections are with very unusual organisms such as the tiny lung parasite *pneumocystis*, or fungi and yeasts such as the common thrush yeast (*candida*) or the much rarer fungus *aspergillus*, or the virus *cytomegalovirus* (CMV). Antibiotics, anti-fungal and other treatment will be necessary, and the child can rapidly become critically ill. By this time there will usually be suspicion that the baby has some defect in its immune system, but many other possibilities are present, such as infections with the AIDS virus. This will often prompt further referral to a specialist centre, which may be some distance away and can cause practical problems - especially if there are other children to be looked after at home.

Our immune system protects us against invasion by all the potentially dangerous organisms in the environment - bacteria, viruses, yeasts and fungi, and parasites. It derives from stem cells in the bone marrow, which develop into several different types of white cell - those which first encounter and “recognise” the organisms as foreign,

those that develop the ability to attack infected body cells on instructions from the recognition cells, those that are instructed to produce protective antibodies against particular parts of the organisms (both of these are lymphocytes), so that finally the invading organisms can be “mopped up” by a fourth set of cells, phagocytes.

Children with SCID do not have any tonsils or thymus gland in the upper chest (both of which are large aggregates of many of these immune cells), which may be picked up at any point, but is likely to be evident by this time. At this point also, a variety of tests will be done, the most important being a look at the white cells in the blood. If this shows a very low count of a particular group of cells in the blood (lymphocytes, especially those with a CD4 antigen on their surface which help produce killer cells, and tell others to make antibodies) and tests for AIDS are negative, then suspicions of an immune deficiency are confirmed; if antibody levels are low also, then a diagnosis of Severe Combined ImmunoDeficiency (SCID) is made since both immune cells and antibodies are affected.

This problem was first described in Switzerland in 1958, but did not receive much attention from doctors until the 1960's. Then, however in the 1970's the story of the famous “bubble boy” David Vetter, living inside his sterile plastic environment for 12 years until finally he died, caught the imagination of the public worldwide. Many press reports were published, and a film was even made of his sad story (“The boy in a plastic bubble”), making a star of a young John Travolta; almost unbelievably, this was re-made in 2001 as a comedy (“Bubble boy”).

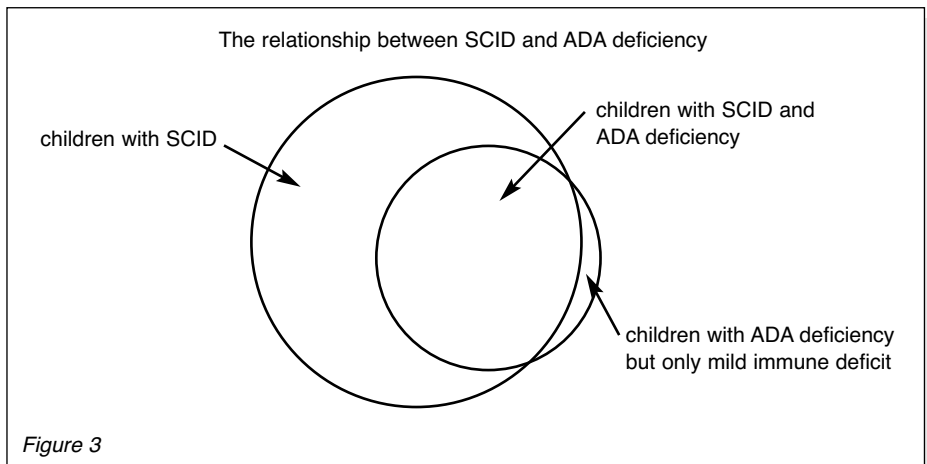

Inherited SCID has more than a dozen different causes, but one of the most frequent of these is deficiency of the enzyme ADA. This diagnosis again can be made on a blood test, and a deficiency of ADA is found in about one in six babies with SCID. The condition is rare: between 1 in 100 000 and 1 in a million births, which means that in any one year, only from one to a handful of babies in the whole United Kingdom will be found to suffer from it. Nevertheless, as related in the next section, its diagnosis and treatment have wider importance.

Often these babies will need blood or other transfusions, and two things are important in this connection. First some of their own blood and plasma should be stored before any transfusions are given, so as to allow subsequent testing of their own blood - and not of the person who donated it! Second, and equally important, the transfusion should be with blood sterilised by irradiation to avoid adding further infections from the transfused blood.

Untreated, it is sad to relate that the great majority of children with SCID from ADA deficiency die, although a few have enough immune function to survive and come to attention much later with infection problems, such as Gillian Lehane and her sister, of whom we shall hear about later. Parents of children who are treated successfully can then face some other problems also associated with the ADA deficiency, as some are hyperactive, whilst other children have some hearing loss.

We can now go on to consider what ADA is, and why it causes such devastating problems in the great majority of people with a deficiency of the enzyme.

What exactly is ADA?

J Stewart Cameron

Why the initials ADA?

A is for adenosine, a compound formed from the purine base, adenine, and the sugar, ribose; and DA is for DeAminase. Thus ADA is the clinical abbreviation for adenosine deaminase. ADA is an enzyme (as the ending -ase implies) - a complex molecule, nearly always a protein, which promotes and dramatically speeds up chemical reactions in living organisms. It is present, expressed and active in every cell and tissue of the human body.

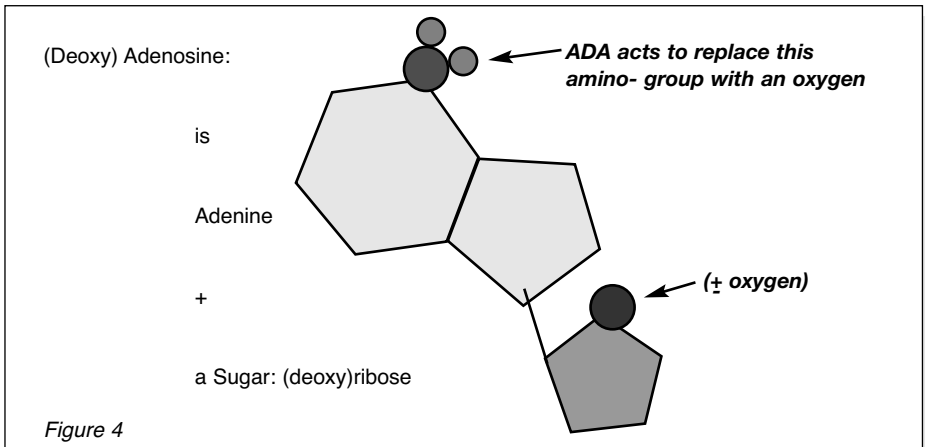

Adenosine (Figure 4) is a *nucleoside*, that is, a compound of a purine base (adenine in this case) and a sugar (in this case ribose). The sugar can also be *deoxyribose*, which lacks an oxygen, in which case the compound formed is called **deoxyadenosine**. **Adenosine deaminase** (ADA) thus acts on both adenosine and deoxyadenosine, to accelerate their conversion into other purine compounds :

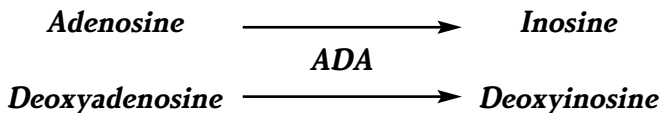

(see Simmonds below).

Adenosine is an important chemical in the body - it is one of the large family of

messengers, or hormones, which trigger cells to do things. It acts on many cells, particularly the blood vessels in muscles to alter their diameter, and hence blood flow. It also acts in the brain and is concerned with sleep - some variant forms of ADA are associated with usually sleeping for a longer or shorter time each night. Also coffee keeps people awake through its action on the receptors for adenosine on brain cells. *Deoxyadenosine* in contrast is only present in the body in tiny amounts under normal circumstances, and is part of the pathway to and from DNA (the D here stands for Deoxy-), but as we shall see it has major consequences if it accumulates - as it does in deficiency of ADA which normally breaks it down.

Despite being present in every cell, however, ADA seems to be absolutely essential only for one sort of cell - some of the white blood cells that form the body's "policemen" which recognise invading organisms, bacteria and viruses etc., and help mount the immune response which destroys them. All these cells are produced in the bone marrow, which suggests one possible line of treatment for affected children (*see Bax below*). Why exactly such cells alone, amongst all those that have ADA, are so dependent upon this enzyme is not yet completely clear, but we do have some ideas as to why its absence is so deadly to them (*see Simmonds below*).

Deficiency of ADA is inherited, and, if it is present, this state usually results in a devastating familial disorder with an almost total inability to combat infection. When such disorders were first described, because both protective cells as well as antibody-producing cells were affected leading to the state of immune deficiency, the condition was called (Severe) Combined Immuno Deficiency, or SCID (*see Cameron above*). Now we know that about one in six children with this terrible problem have ADA deficiency.

After SCID came to wider attention in the 1960s and 1970s, the presentation was then recognised to be similar to that resulting from HIV infection. Since HIV tests were always negative, later it came to be known as 'non-HIV AIDS' in the 1980s and 1990s.

How is ADA deficiency inherited?

Our DNA is arranged in chromosomes within the nucleus of our cells. We all have 23 pairs of chromosomes, and each chromosome has two copies - a pair. This DNA within each cell forms a huge "book" of altogether three billion purine and pyrimidine bases, which form huge strings within each chromosome. Along this DNA are found

some 24 000 messages or genes, each formed by a string of DNA, each of which codes for a particular protein. The gene which codes for the protein of ADA is found on the long arm of chromosome 20 out of the 23 pairs of chromosomes we all have (see *Marinaki below for details*).

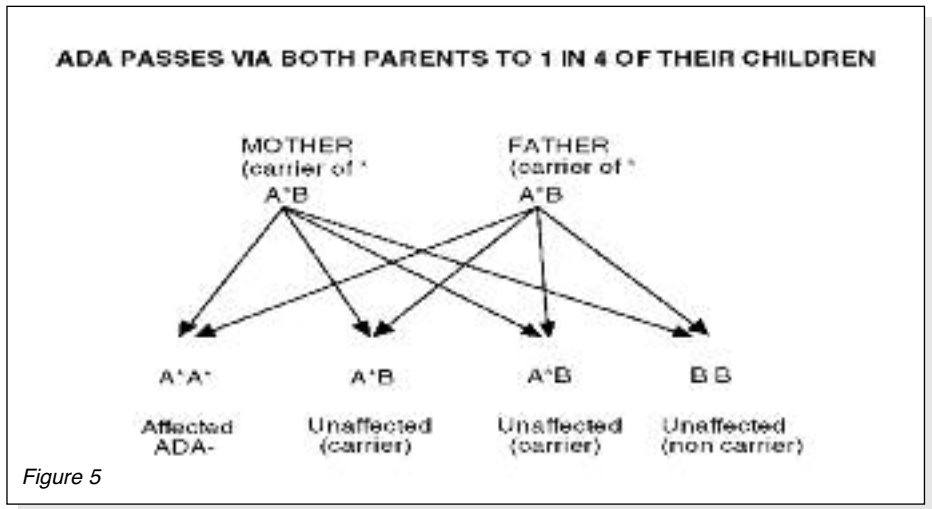

One of each pair of genes in any individual comes from the mother, and one from the father. In the case of ADA deficiency a person with one chromosome bearing the defect will be a carrier, capable of passing on the disease, but without any problems themselves. However, if two carriers (like Lesley & Peter) have children, there is the possibility that some of their children will receive *two* copies of the defective gene (one from each parent) and be unable to make normal ADA, thus inheriting ADA deficiency. A moment's calculation shows that the chances of any one child of two carriers being normal, or of inheriting the disease, are both 1 in 4; whilst the chance of being a carrier like their parents is 1 in 2 (Figure 5). There is also the possibility that the defect on one of the two chromosomes in the cells of either parent or the patient is a new mutation.

The family tree of Lesley and Peter shown in Figure 6 (below) is thus typical of what is called a **recessive disorder**. This family tree illustrates also the potentially lethal nature of ADA deficiency when the defective gene is inherited from both parents.

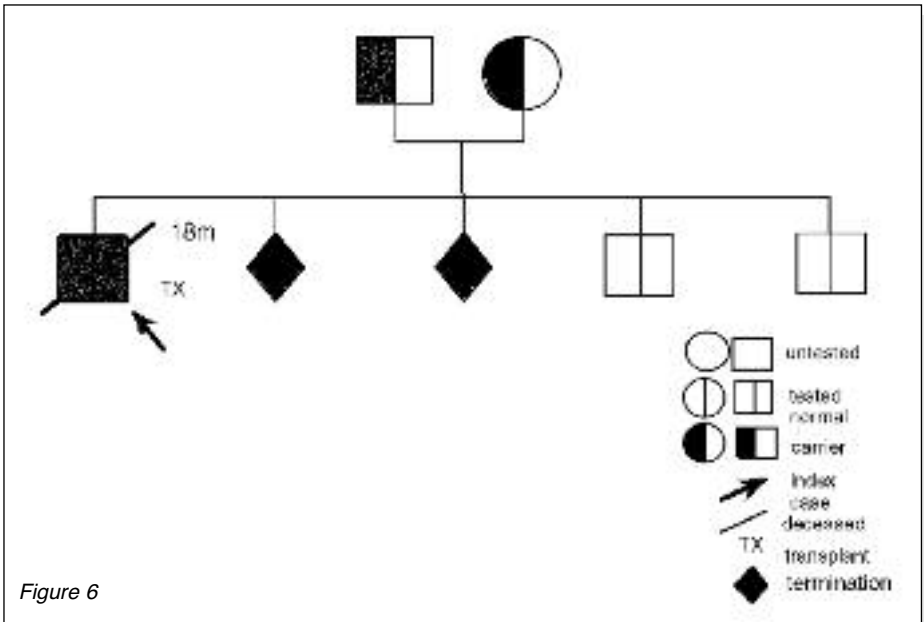

Figure 6

ADA deficiency is such a serious disease that the development of techniques for counselling backed up by prenatal detection and embryo selection, has been a major priority. This has been rewarded in a number of instances with the birth of healthy children, as illustrated in Figure 2 above.

However one can never prevent the problem of new mutations arising, or of the disease appearing for the first time in a family, so priority must also be given to treating those unfortunate infants and children who already suffer from the disease. Although rare, because ADA deficiency is both a disorder resulting from a mutated gene and directly arises from a problem with function of bone marrow stem cells, knowledge derived from its treatment may have wide applications to other, commoner disorders.

Why is ADA so important?

Anne Simmonds

The story of Lesley and Peter illustrates the impact on parents faced with the diagnosis of ADA deficiency for the first time. It highlights the subsequent sequence of events (*see Cameron above*) which led to their child having to be kept in a sterile 'bubble'; of the importance of the development of successful techniques such as bone marrow transplantation and prenatal detection, enabling the birth of healthy children for those who so wish. Now gene therapy (*see Gaspar*) has become a possible form of long-term treatment.

It is helpful for parents when their baby is first diagnosed with a life-threatening genetic metabolic disease, such as ADA, to be able to contact other parents who have been equally devastated when faced with such a diagnosis. PUMPA has a patient support member who can be contacted regarding other such parents, or members able to help them (*see p35*)

Why do we need ADA?

Our first booklets explained that purine nucleotides and deoxynucleotides are chemicals basic to life. Making them afresh involves a ten-step route which uses up a lot of energy. Consequently it is not only 'cheaper', but more efficient in terms of energy, that when nucleotides break down through daily wear and tear (muscle work, wound healing, etc.) such 'waste' is recycled (salvaged) by the enzyme HPRT (for Hypoxanthine Phospho Ribosyl Transferase- the enzyme defective in LND, as described in our first booklet. This recycling takes only one step, instead of ten. Our

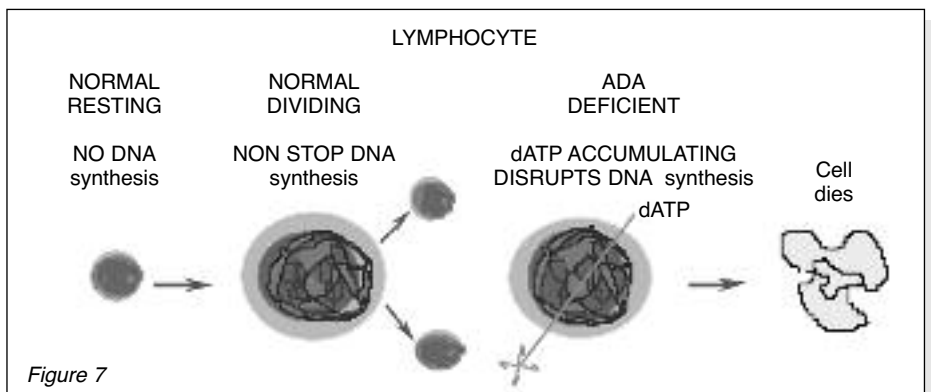

main focus here, however is an equally important function: the role of purine compounds in the ability of the immune system to make extra cells (in this case lymphocytes) rapidly, to attack invading bacteria, viruses, parasites, etc. (Figure 7). In most cells DNA is stable, but rapidly dividing cells need to make large amounts of DNA very quickly, and also as they die after use, DNA is rapidly broken down (see *Cameron above*). Problems arise in both of these areas in ADA-deficient children.

How was ADA deficiency discovered?

The first recognition of ADA deficiency occurred by pure chance. Eloise Giblett, a haematologist in the USA studying different populations for the type of ADA they had in 1972, to her surprise noticed that two of the children in the study had no detectable ADA at all. Both proved to be children with severely impaired cellular immune function. In both, a complete deficiency of ADA was confirmed later as the cause of their inability to combat infection.

In those early days, now thirty years ago, it was difficult to understand why a deficiency of ADA should be so devastating. The state of our knowledge then indicated that adenosine (Ado) is so important for making ATP that it is normally recycled to ATP. Thus, ADA appeared to be a shunt-line used only in extreme overflow situations:

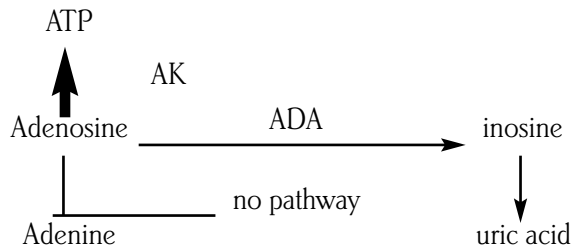

Figure 8

A main substance excreted by the famous “bubble” boy in Texas (see *Cameron above*) was described as adenine - but there was no way by which adenine could arise from adenosine in the human body. Nevertheless we decided to use our new techniques developed to study APRT deficiency in kidney stones to search for ADA deficiency among immunodeficient children in London. The doctors in Texas kindly sent a urine sample from their patient, but using our special techniques, we found to our surprise not adenine, but a chemical we had never seen before. We persevered and were able to identify this so-called ‘adenine’ eventually as *deoxyadenosine*

(dAdo) (see diagram in Cameron above), which had never been reported in human urine previously. But the Texas group had not made a mistake: they identified this urinary compound correctly as adenine using the systems they employed. The problem was that the deoxyadenosine had broken down chemically (i.e. outside the body) to adenine in the urine. Fortunately by pure chance we used a different gentler method which allowed the dAdo to survive.

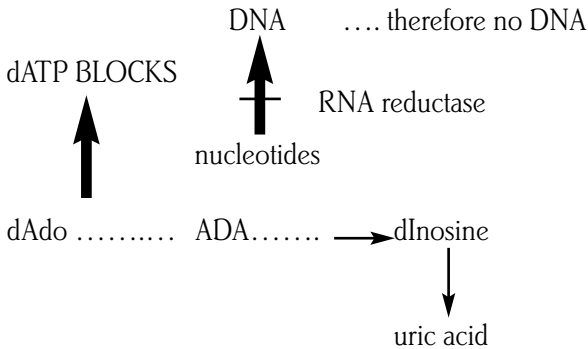

Figure 9

The finding that the abnormal purine accumulating in the urine in ADA deficient children was dAdo represented an important step forward. We searched all of the published scientific literature, which revealed the existence of enzymes that could make deoxyATP (dATP) from dAdo within our cells. More importantly, **dATP was reportedly a powerful inhibitor of an enzyme called ribonucleotide (RNA) reductase, vital for making new DNA.**

Inability to replace the DNA lost daily during the normal immune response to infection explained the lack of white cells and the immunodeficiency. All this happened in 1977, when we found also that dAdo was picked up by red blood cells, as well as white cells, from ADA deficient patients and made into dATP, which has proved a vital diagnostic tool (see Fairbanks).

Why the immunodeficiency?

We have already learned what the absence of ADA means in clinical terms (see Cameron above). However, ADA deficient patients have advanced our scientific knowledge by demonstrating that ADA serves a special function of vital importance in our body: namely, in removing the dAdo which results from DNA turnover in cells, when they need to divide rapidly to combat infection.

In the absence of ADA, dATP accumulates, which is especially toxic for the cells of the immune system; at the same time, the vital energy molecule ATP is depleted. In addition, dAdo inactivates another enzyme called SAH hydrolase (S-adenosylhomocysteine hydrolase) involved in breaking down SAHH (S-adenosyl-L-homocysteine), which should it accumulate, is a potent inhibitor of vital reactions involving a chemical processes called methylation.

How do we diagnose deficiency of ADA?

DIAGNOSIS OF ADA IN THE LABORATORY

Lynette Fairbanks

The experience related in chapter 1 is the same for all families where both parents each carry one copy of a defective ADA gene (Figure 5) and underlines the fact that ADA deficiency needs to be recognised and treated very early. Although ADA is present in all human cells and tissues, laboratory diagnosis is not always easy. Blood tests suggestive of SCID (*see Cameron above*) show:

- lymphocyte counts significantly below normal
- lower-than-normal levels of B cells and T cells
- deficiency of the immunoglobulins normally produced by B cells

ADA deficiency must then be confirmed as the cause of the SCID by measuring ADA in the blood.

Pitfalls which makes diagnosis difficult

Measurement of ADA activity in disrupted red blood cells.

The first technical problem is that the catastrophic clinical presentation of ADA deficiency may necessitate immediate blood transfusion. In such cases, ADA activity in the donor red blood cells will make laboratory diagnosis from red cells, impossible for up to six months. In this case a skin biopsy may need to be taken and cultured for confirmation. It is sometimes difficult to establish that there has been a blood transfusion, since the infant may have been referred from one different Regional hospital to another previously.

The second problem is that **ADA activity is reduced considerably if blood is stored in a freezer** at -20°C and the patient may thus appear to have low to zero activity. Consequently, if blood has to be sent long distances, the Guy's Laboratory must be contacted in advance for advice.

Unusual metabolites in blood and urine can signal ADA deficiency.

Earlier **PUMPA** booklets have reported that disorders under its umbrella may be diagnosed from a specific compound not normally present, or a normal compound present in unusual amounts (raised or absent) in blood and/or urine. The same holds true for ADA, which can be confirmed in this way. **The specific and characteristic metabolite detected in ADA deficient patients** is the unusual presence in urine of **dAdo (deoxyadenosine)**, which, as discussed above, is a

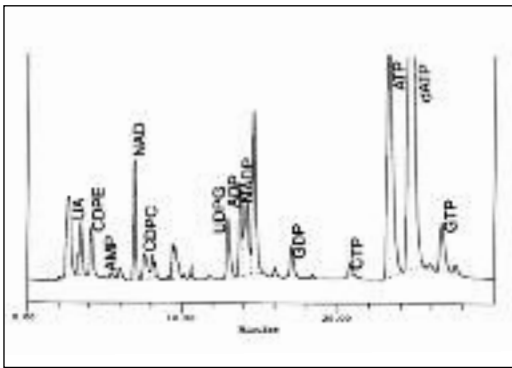

DNA breakdown product. dAdo is not present in urine of healthy subjects. Stringent precautions for collection of such samples are vital - especially urine - including use of sterile containers with preservative (a few thymol crystals) to avoid bacterial contamination, which readily degrades dAdo - not easy in babies, or young children. dAdo is

also taken up by the red blood cells in ADA deficiency, and accumulates as dATP (Figure 10) in addition to ATP, the principal purine in red blood cell extracts. dATP may reach high concentrations (*see Table*) eventually lowering ATP - another useful diagnostic tool - providing, as above, that there have been no recent blood transfusions.

An additional point arises in some late-presenting patients, no longer infants (*see Webster and Lehane below*) with particular mutations in their ADA gene (*see Marinaki below*) and ADA deficiency. Although there is no ADA activity in their red cells, some activity may be present in their lymphocytes. Specific assays for enzyme activity will have to be done on these cells after separation from blood to establish this, but in general the dATP levels in red blood cells will be lower, and ATP levels higher, than in those infants with complete deficiency.

ADA Deficiency - Molecular Diagnosis

Dr Tony Marinaki

As Dr Cameron has outlined above, the DNA carrying all our genetic messages is located in chromosomes within the nucleus of our cells, and each chromosome has two copies - a pair. All genes are made up of code “words”, each made up of trios of DNA nucleotides, each of which specifies a particular unit (amino acid) from which a protein chain is built up. ADA is a medium-sized protein molecule (110 kDa), made up of two identical chains of 362 amino acids.

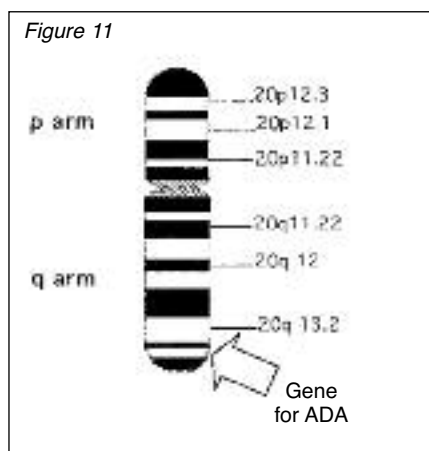

In ADA deficiency an individual with one Chromosome (shown in the diagram), bearing the defect will be a carrier, capable of passing on the disease but without any problems themselves. However, if two carriers have children, then there is the possibility of some of their children having both copies of the gene with the defect (see Cameron). However, there is also the possibility that the defect on one of the two chromosomes of either parent is a **new mutation**.

The message (gene) for these chains is found in the string of DNA which forms the long (q) arm of the chromosome designated no. 20 (Figure 11) out of the 23 pairs we each have in every cell, at a site designated 20q13.2-qter. The ADA gene is not a particularly large one, having 11 coding regions (called exons) within it.

The copies of this gene are inherited in what is called a recessive fashion, again as Prof Cameron outlined above: one chromosome of each pair comes from the mother, and one from the father.

Normally the gene is copied without problems each time a cell divides, including in the cells which go to make sperm and eggs. However at any point, in the distant or the immediate past, an alteration (mutation) may have arisen, which can interfere with the activity of the ADA enzyme. Today more than 60 different types of mutation have been described in the ADA gene which can interfere with its activity. As already

noted, *both* genes have to be abnormal to induce disease. Usually, there is a different abnormality in each of the two genes inherited from either parent.

An important point is that although most of these 60-odd mutations completely abolish activity, a number leave the enzyme very inefficient, but still capable of exerting some action. Thus some individuals with mutations even in *both* ADA genes have a small amount of ADA activity left. Since only 3% of normal is needed to remain well (although there may be some problems at this level) we find people who survive childhood and may develop “only” milder disease in later childhood, or even as adults, such as Gillian (*see below*); as well as a few lucky individuals who are apparently quite normal, even though both copies of their ADA genes are abnormal.

ADA deficiency is rare disorder, however the chances of disease emerging are much higher in families where intermarriage between closely-related families is common, and above all if cousins marry: all recessive conditions are commoner in cousin-to-cousin marriages. ADA deficiency thus occurs relatively frequently in some Asian communities, or families of Irish origin as in the kindred below (note only confirmed carriers are indicated. Samples were not available from other members)

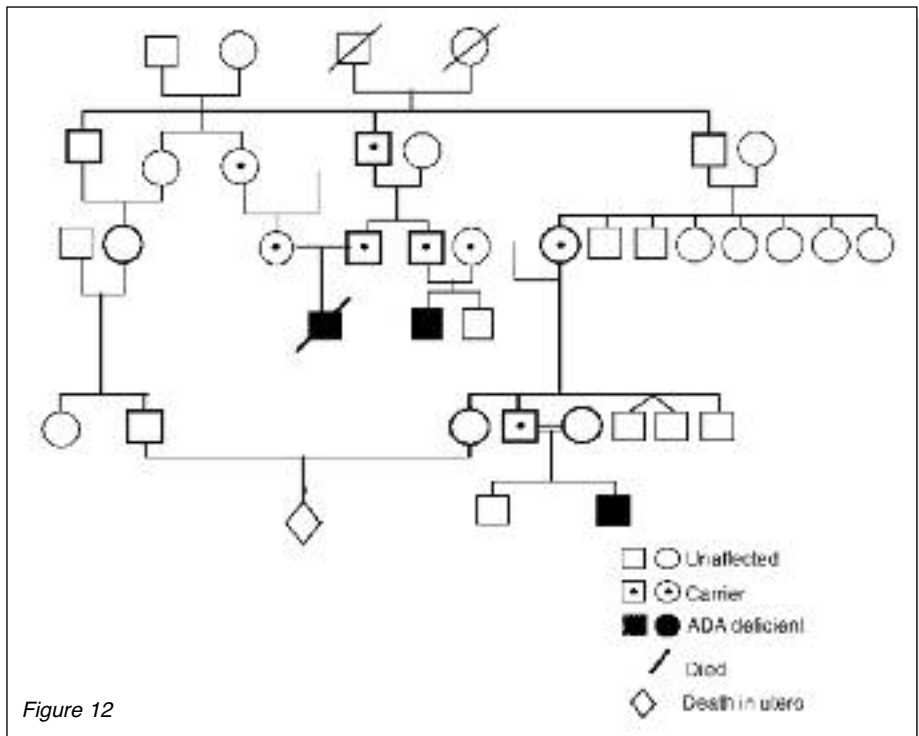

Figure 12

It is recommended that families with ADA deficiency receive genetic counselling. Parents who are both carriers of an ADA mutation have a 25% chance of having an affected child. In families where inter-marriage is likely and some members have been diagnosed with ADA deficiency, screening prospective parents for ADA deficiency is the first step in determining whether their children are at risk for inheriting the disorder. Although carriers are predicted to have 50% ADA activity this is unfortunately not always the case and genetic testing is preferred as it is more accurate in families where the mutation is known. Prenatal testing is available should this be requested.

Finally, information obtained by molecular diagnosis can be invaluable in counselling families as to what course is best in the future to achieve the birth of normal children.

Advances in treating ADA deficient patients, including Gene Therapy

WHAT ARE THE PROBLEMS AND PRIORITIES IN TREATING ADA DEFICIENCY?

Bobby Gaspar

The major problem is the immune system, which normally copes with infections. In the majority of patients with ADA deficiency, the immune system is very poorly developed putting patients at risk of serious infection. If unrecognised and untreated children with complete ADA deficiency are likely to die in the first year of life. A small number of cases are less severely affected and can survive for a few years, but also eventually run into problems with severe infection.

The first priority once ADA is recognised is to treat and control any infections. Often children present with chest infections, severe diarrhoea and failure to gain weight. All of these problems must be treated first to stabilise the child and return them to some level of good health. This will involve the use of intravenous antibiotics and replacement of immunoglobulin since these children are unable to make antibodies of their own. Feeding is also a very important issue. Such children are often very malnourished and have lost weight, partly because of the recurrent infections but also because the disease itself may harm the gut. A variety of feeding methods including feeding through a nasogastric (NG) tube, or straight into the bloodstream and bypassing the gut (TPN-total parenteral nutrition), are sometimes used to increase the child's weight and nutritional status.

Once acute infections have been treated, the next priority is to prevent further infections. This involves the use of antibiotics which are taken regularly. Children are also given infusions of immunoglobulin every few weeks. However these measures are just a stop-gap and will not keep the child well forever. The next step is to replace, or rescue, the child's immune system so that they can now fight infection properly. There are three ways in which this can be done.

How do we treat ADA deficiency in the long-term?

1) Bone marrow transplantation (BMT)

The immune system grows from the bone marrow. Consequently, in severe immune deficiencies such as ADA deficiency, one method of treatment is to replace the bone marrow and grow a new working immune system.

The first step is to find a suitable bone marrow donor. The cells of the immune system have markers on their surface which differ from one person to another. This is called a person's 'tissue type'. The tissue type of the patient is first established and a search is made for someone who has the same tissue type. The best match comes from a brother, sister or family relative with an identical tissue type. However, this is available for a small number of patients. The next option is to search donor registries such as the '*Anthony Nolan Donor bank*' or '*cord blood banks*' to find an 'unrelated donor'. If none is available, a transplant from a mismatched parent can be performed.

Bone marrow transplants (BMT) from matched relatives are very successful with more than 9/10 children surviving. Usually such a transplant can be done without any chemotherapy and so the risks of chemotherapy are avoided. Transplants from matched unrelated donors, or cords, do involve some chemotherapy to make space in the bone marrow of the patient receiving the incoming donor marrow. In general, BMT from unrelated donors are riskier than a BMT from a matched relative but in certain centres with the use of less powerful chemotherapy drugs and with the advances in transplant techniques, the outcomes are very good.

If no matched donor can be found, a transplant from a parent (who is usually only half matched with the child) is performed. Under these conditions, the outcome is very poor and only half the children treated will survive.

2) Enzyme replacement therapy (PEG-ADA)

An alternative treatment is the use of PEG-ADA (*see Bax*) - essentially a drug in which bovine ADA (enzyme from a cow) is mixed with a carrier (PEG) and is given to the patient on a regular basis as an injection. This form of treatment can work very well and in most cases, children clear their biochemical problems very quickly and with time start to recover their immune systems. The experience in ~150 patients suggests that although children remain well on PEG-ADA, the immune system does not recover fully and patients often need to stay on antibiotics and antibody replacement.

PEG-ADA is often used while waiting to find a suitable bone marrow donor and so is an intermediate step in stabilising the child before a BMT can be done. In some children where a donor cannot be found, PEG-ADA has been used for over 10 yrs. In these cases, children can remain very well but their immune systems run at low levels and so their long-term outcome is uncertain.

3) Gene therapy

The gene responsible for ADA deficiency was first identified in 1983, eleven years after the deficiency itself was first recognised. Since then there has been much research into trying to cure the disease by gene therapy. The principle of gene therapy involves taking bone marrow from the patient, selecting the very early stem cells and introducing a working copy of the ADA gene into these cells before returning them to the patient. The gene-corrected bone marrow cells are then able to grow and develop into a functional immune system. Gene therapy has a number of potential advantages over BMT in that by using the child's own cells one can avoid a major complication of BMT, called graft versus host disease. In addition, the patient is spared large amounts of chemotherapy and there is no need to wait to find a donor.

Although initial trials were unsuccessful, recently there has been a major breakthrough in treating ADA deficiency by gene therapy. Groups in Italy and the UK have shown that gene therapy can restore a patient's immune system. In both centres, early stem cells were isolated and corrected by introducing into them a working copy of the ADA gene.

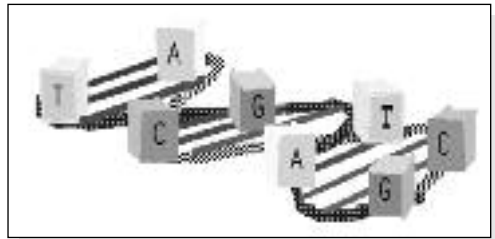

The patients were then given a small dose of chemotherapy (much lower than would be given for a BMT) before replacing the gene corrected cells. In all patients, PEG-ADA was stopped before the gene therapy procedure. After 6-12 months, there has been a slow but steady growth of the immune system in all patients treated. A number of patients have now stopped all medications and are leading normal lives. Thus gene therapy holds much promise for the future, but like all new treatments, these patients must be monitored very carefully to make sure gene therapy continues to work and does not cause any harmful side-effects. If these initial successful results are reproduced in larger groups of patients, then gene therapy may become the standard treatment for patients with ADA deficiency who have no suitable bone marrow donor (Figure 13).

ADA is not always a disease of childhood

AN UNUSUAL VARIANT OF ADA IN ADULTS

David Webster

Complete deficiency of ADA results in a total inability to combat infection due to the toxic effects of deoxyadenosine (dAdo) on white blood cells. The problem is that the red blood cells and lymphocytes of patients with no ADA cannot remove this toxic waste. Instead they convert it to deoxy ATP (dATP) (*see Simmonds and Fairbanks*), which is a potent inhibitor of any new DNA formation.

Since the first severe case of ADA deficiency was reported (the presentation of which is described so vividly here by the Wilkinsons) there has been considerable variation in the age of presentation and diagnosis. Some patients are called 'late presenters' because they have retained a small amount of ADA activity in their cells, so some of the toxic dAdo is removed. This in turn helps to explain the milder symptoms and late onset of the life threatening consequences characteristic of complete ADA deficiency. However, it is still a mystery how such individuals survive through childhood with such a severe defect. The oldest reported patient with late onset ADA, up until 1993, was 15 years of age. In that year a chest physician at a meeting was describing two sisters in their 30's who had suffered recurrent chest infections in their 20's and developed the many problems associated with a severely reduced number of lymphocytes. The possibility considered was HIV disease (AIDS), but both were HIV negative. The finding of two sisters developing exactly the same symptoms suggested an inherited genetic disorder; the fact that the immune system was severely impaired in both cases also raised the possibility that this might be an unusual presentation of ADA deficiency. The Purine Research Laboratory was contacted, but were sceptical too - and subsequently very surprised, to find on analysing the red blood cell extracts of both sisters, a pattern similar to that in Fig 10 (*see Fairbanks*), but in the case of the two sisters the dATP was much lower than in affected infants and the ATP levels normal (*see Table below*). Although there was no ADA activity in the disrupted red cells, low activity was present in lymphocytes.

The important message here is that ADA deficiency should not be ruled out as a possible diagnosis in either adults or children. They may be late presenters who have much milder symptoms. ADA deficiency clearly displays considerable variability in expression which may be influenced by additional undefined factors. Available forms

of treatment for such patients include ADA replacement with PEG-ADA or ADA entrapped within erythrocytes (see Bax below), bone marrow transplantation and recently gene therapy (see Gaspar above). The choice of treatment must be tailored to each individual case.

Subjects	Age range	ATP	Red blood cells		Lymphocytes
			dATP (fmol/l)	ADA activity* (fmol/l)	ADA activity*
Control adults	>18 years	1281 ± 132	Nil	(40-100)	(1160-4500)
Control children	<2 years	1570 ± 97	Nil	(40-100)	No data
ADA- children	<2 years	1602	680	0	0
Adult 1 (35yr)		1092	234	0	68
Adult 2 (36yr)		1469	105	0	55

* (nmol/h/mg protein)

Alternatives to bone marrow transplantation

Bridget Bax

For success in bone marrow transplantation, the more identical the body tissues between donor and transplant patient, the better. As discussed by Dr Gaspar, all tissues contain specific marker molecules called HLA antigens that give each of us our own unique individuality. This process of comparison is called matching. Without a good match, graft-versus-host disease (GVHD) may occur. This is where the immune cells from the donated bone marrow (graft) attack the body tissues of the transplant patient (the host). Finding a good match is not easy, and unfortunately only 25 to 30% of patients have matching donors, and even with a good match, bone marrow transplantation is not always successful.

Fortunately, another treatment option known as enzyme-replacement therapy is available for patients without a suitable bone marrow match, for patients who are waiting for a suitable bone marrow donor to be identified, or for patients where BMT has failed. Enzyme replacement therapy involves replacing the patient's defective enzyme with injections of purified ADA. A good source of ADA is from the intestines of cattle (bovine ADA), but because it is from another species, the human body would recognise it as a foreign protein, and eliminate it from the blood circulation within a few minutes of injection. To provide an effective therapy, ADA needs to remain in the blood circulation for much longer and ideally, continuously. Today, two different types of replacement therapy are available clinically: enzyme replacement with PEG-ADA, and enzyme replacement with carrier erythrocyte-entrapped ADA. Both therapies were developed with the aim of increasing the circulatory life-span of bovine ADA.

PEG-ADA

PEG-ADA (polyethylene glycol-modified bovine ADA, also known as Pegademase or ADAGEN) is a drug produced by linking many molecules of polyethylene glycol (PEG) to purified bovine ADA. PEG is a non toxic chemical polymer and improves the life-span of bovine ADA by shielding it from being recognised in the body as a foreign protein. PEG-ADA is administered by intramuscular injection once or twice a week and works in the plasma (the fluid in blood in which red blood cells are

suspended) by converting the accumulated deoxyadenosine (dAdo) to deoxyinosine (dIno), which is the normal breakdown product of ADA (see Simmonds above). dIno is recycled for other uses, or is converted to uric acid for excretion in the urine (Figure 11). The elimination of dAdo from the plasma reverses the uptake and accumulation of dAdo by cells so that dATP levels fall to normal. This metabolic correction leads to an improvement in the number of white cells (lymphocytes) and a decrease in recurrent infections, allowing patients to lead nearly normal lives. However in some patients, inactivating antibodies can eventually form against PEG-ADA, causing a decrease in the number of total lymphocytes. This can be overcome by increasing the dosage of PEG-ADA, but at a cost of £250,000 to £400,000 per year to treat a 12 year old child, and over £700,000 per year to treat an adult patient, this option may not be affordable.

Erythrocyte-entrapped ADA

Below Gillian Lehane describes her experiences as an adult patient with ADA deficiency. Gillian is without a matched bone marrow donor and unfortunately she developed antibodies to PEG-ADA after two years of treatment. For the past 10 years Gillian has been receiving carrier erythrocyte entrapped ADA therapy. Erythrocyte is the scientific term for the red blood cell and for many years scientists have been interested in the potential of using the patient's own red cells as drug carriers in the blood. Erythrocytes when put into water or a solution containing a very low concentration of salts, swell and holes will form in the membrane. At this stage if we add drugs to the solution, these will pass through the holes into the erythrocyte. If the erythrocytes are then re-suspended in a normal physiological salt solution, the erythrocytes demonstrate a seemingly magical property of shrinking and resealing themselves, to become normally functioning cells, but now containing entrapped drugs.

Erythrocytes survive in the circulation for up to 120 days, and so by entrapping ADA inside them, we can potentially increase the life-span of ADA to that of the erythrocyte, by preventing it from being recognised by the body as foreign. ADA is too large to leak out across the erythrocyte membrane, but small molecules such as dAdo and dIno can cross the erythrocyte membrane in both directions. By using erythrocytes as carriers of ADA in the circulation, accumulated plasma dAdo can enter the erythrocyte, where the entrapped bovine ADA converts dAdo to dIno. As shown in Figure 14, the dIno is then free to move out of the erythrocyte to the plasma,

from where it is converted to uric acid for excretion or recycled. As with PEG-ADA, the elimination of dAdo from the plasma reverses the cellular accumulation of dAdo, allowing dATP levels to return to normal.

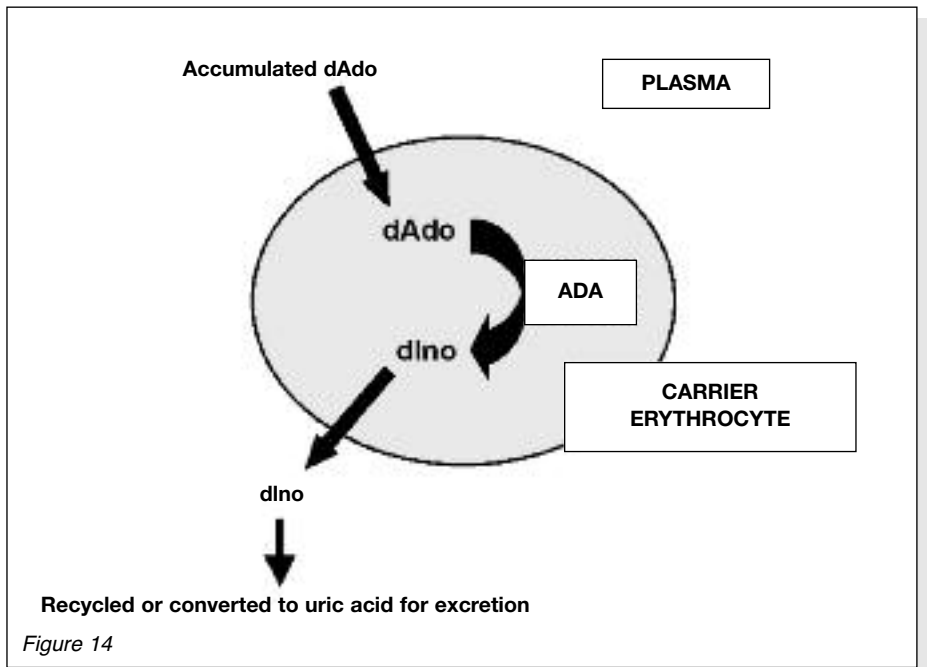

One of the advantages of this type of enzyme replacement therapy is that because ADA is entrapped in the erythrocyte, it is hidden from recognition by the rest of the body, and thus inactivating antibodies cannot form against the ADA. Also, the costly process of linking PEG groups to ADA is not required, making this therapy more affordable. Therapeutic interventions may be reduced from the once or twice a week as with PEG-ADA, to once every two to three weeks. Because the patient's own erythrocytes are used to entrap the ADA, transmission of blood disease is prevented.

Although enzyme replacement therapy is an effective treatment, it is not curative, and for this reason other treatments such as gene therapy are being assessed.

Long term treatment with erythrocyte encapsulated ADA

A PATIENT'S EXPERIENCE

Living with Adenosine Deaminase (ADA) Deficiency

Gillian Lehane

I am 49 years old and have been married to Michael for 22 years. We are lucky to have two sons, Samuel, who is now 2017 years of age, and Joshua, who is 14 years old. I have one sister and three brothers. Sadly both my parents have passed away.

As far back in my childhood as I can remember I had problems with my chest, either infections or pneumonia. I was in and out of hospital and this caused my parents a lot of worry. Even in my teens I had recurrent chest problems but I don't remember them stopping me doing the things other teenagers did. I even smoked up until the time we wanted to start a family.

When I left school I started work as a nurse for patients with special needs, a rewarding job that I managed to do for 15 years. At the age of 33 years I was given a medical discharge due to constantly being off sick; I was therefore able to stay at home with Samuel, then 4 years old, and one year old Joshua who was in and out of hospital with chest problems due to his pre-term birth.

Joshua was delivered 3 months early by caesarean section due to my ill health. My chest got very bad during this pregnancy, the doctors didn't know what was wrong with me, and I thought we were both going to die. Joshua was fighting for his life in a special baby care unit with heart and lung problems, and I was about to have an open lung biopsy. The doctors still didn't know what was wrong. I was ventilated to give my lungs a rest, and I remember being told I may not survive. I was about to be listed for an emergency heart and lung transplantation and was given some chemotherapy as a last resort. By some miracle I got better.

My diagnosis remained elusive until my case and that of my sister Jacqueline, who also had severe chest problems, was discussed at a meeting of doctors. It was ADA deficiency. At last I knew- I was not scared or shocked as I shared this diagnosis with Jacqueline from whom I drew much support. We used to go for our treatment in London together. It was the worst thing to watch Jacqueline dying, despite all the

treatment she was having. She was only 16 months older than me and I thought that it would be my turn next. She was only 38 years old when she died, leaving a 3 year old son, Thomas. That was 1310 years ago and I am still alive, I thank God for that.

Thomas is a big part of our daily life and I drive him to school with my sons, and cook his meal in the evenings. I care for him as if he were my third son.

I don't think about my ADA deficiency unless I become unwell and then I think that this might be it. I just get on with life and take every day as it comes. I don't feel sorry for myself as there are so many people worse off than me. I consider myself to be very lucky to still be here.

I take a lot of medication: steroids, nebuliser and puffers for my chest as well as antibiotics daily and calcium for my thin bones and a fortnightly **infusion of erythrocyte entrapped ADA** (see *Bax above*). I have osteoporosis due to long-term steroid use, and fell and broke my hip 5 years ago. I am very particular about all aspects of hygiene, both inside and outside my home. I always carry anti-bacterial wipes and try to avoid crowds, and never use public transport. If any of my friends or family is unwell they are very careful not to pass it on to me. I am sure these precautions have helped me in my fight to survive.

I have a caring family and my life is very full with my family. I also have my girls' night out where we have a few drinks and a dance, or see a show, so I do not let my illness control my life. I am very proud of my sons and of their achievements. I look forward to watching them fulfill their career dreams and get settled in life. What more could I want?

As told by Gillian Lehane

GENETIC COUNSELING AND PRENATAL DETECTION

Genetic Counselling is available via your local Regional Hospital, or at a Central Referral Centre, such as the Hospital for Sick Children, Great Ormond St (GOS), London, or at Guy's Hospital, London Bridge, SE1 9RT, to which you will need be referred by your GP.

Prenatal detection of ADA deficiency requires consultation through your GP and prior arrangements with the only centre where this has been set up, and is currently available in Britain:

The Purine Research Laboratory, 5th Floor, Thomas Guy House, Guy's Hospital London, SE1 9RT GB (*see Contact addresses- Dr Fairbanks and Dr Marinaki*).

However, staff **must** be contacted **well** in advance if possible.

DIETARY INSTRUCTIONS

Instructions for a low purine caffeine-free have been given in all the previous booklets because a high purine diet could add to the problems in the disorders described in those particular booklets i.e. the development of gout or kidney stones.

Instructions for low purine diets are not really relevant in ADA deficiency.

For babies presenting with SCID, the first approach must be to improve nourishment as early as possible, even before the diagnosis of ADA deficiency (as the cause of SCID) is made.

For those infants or children that may be malnourished, high calorie feeds, or calorie supplements are given, and may be necessary also following Bone Marrow Transplantation (BMT), or gene therapy.

The Dietary Department at GOS has published an excellent booklet for families of children with SCID, which is available on request, called "Severe Combined Immunodeficiency. Information for families." This booklet could be extremely helpful to all families with ADA deficient SCID as well.

Contact for this booklet is: Vanessa Shaw, Head of Dietetics, Great Ormond Street Hospital for Children NHS Trust, London WC1N 3JH

IMMUNISATION

If a child has SCID, it should not be immunised with live viruses, like the chicken pox (varicella) or measles, mumps, and rubella (MMR) vaccine. This is because a child with SCID lacks the normal defense of developing antibodies to viruses. Consequently, introducing a virus, even a weakened vaccine virus, can be dangerous.

SUGGESTIONS FOR FURTHER READING

“Severe Combined Immunodeficiency. Information for families”. Obtainable from Vanessa Shaw, Head of Dietetics, Great Ormond Street Hospital for Children NHS Trust, London WC1N 3JH

Gaspar HB, Thrasher AJ. Gene therapy for severe combined immunodeficiencies. *Expert Opin Biol Ther.* 2005;5:1175-1182.

Rogers MH, Lwin R, Fairbanks L, Gerritsen B, Gaspar HB. Cognitive and behavioral abnormalities in adenosine deaminase severe combine immunodeficiency. *J Paediatr.* 2002; 139: 44-50

Fischer, Alain. Primary Immunodeficiency Diseases: An Experimental Model for Molecular Medicine. *Lancet* 357, no. 9271 (2001): 1863-1869.

Bax, B.E., Bain, M.D., Fairbanks, L.D., Webster, A.D.B., Ind, P.W., Hershfield, M.S. and Chalmers, R.A. (2007) A nine year evaluation of carrier erythrocyte encapsulated adenosine deaminase therapy in a patient with adult-type adenosine deaminase deficiency. *European Journal of Haematology*, 79, 338-348.

Bax, B.E., Bain, M.D., Fairbanks, L.D., Webster, A.D.B. and Chalmers, R.A. (2000) *In vitro and in vivo* studies of human carrier erythrocytes loaded with polyethylene glycol-conjugated and native adenosine deaminase. *British Journal of Haematology*, 109, 549 -554.

Bax, B.E., Bain, M. D., Fairbanks, L. D., Simmonds, H. A. Webster, A.D.B, and Chalmers, R. A. Carrier erythrocyte entrapped adenosine deaminase therapy in adenosine deaminase deficiency. (2000) *Advances in Experimental Medicine and Biology*, 486, 47-50.

Giblett ER, Anderson JE, Cohen F, Pollara B, Meuwissen HJ. Adenosine-deaminase deficiency in two patients with severely impaired cellular immunity. *Lancet.* 1972;2: 1067-1069.

Meuwissen HJ, Pollara B, Pickering RJ, Porter Ian H. Hook EB, Kelley S. In: *Combined Immunodeficiency Disease and Adenosine Deaminase Deficiency: a molecular defect.* Academic Press, 1975, New York.

Simmonds HA, Panayi GS, Corrigall V. A role for purine metabolism in the immune response: Adenosine deaminase activity and deoxyadenosine catabolism. *Lancet* 1978; 1: 60-63.

Simmonds HA, Sahota A, Potter CF, Perrett D, Hugh-Jones K, Watson JG. Purine metabolism in adenosine deaminase deficiency. In: *Enzyme defects and Immune Dysfunction. Ciba Symposium 68 (new series)*, Amsterdam:Elsevier, 1979: 255-262.

The above articles contain details of a large number of other papers and chapters in books on ADA deficiency. They are aimed predominantly at physicians and other health professionals.

CONTACT ADDRESSES FOR FURTHER HELP

Information and patient support:

Mrs Joan Martin, Patient Support Group, PUMPA tel: 01293 851877

Laboratory diagnosis

Dr Lynette Fairbanks, Dr Tony Marinaki, Purine Research Laboratory, 5th Floor Thomas Guy House, Guy's Hospital, London Bridge SE1 9RT tel: 0207 188 1266, fax: 0207 188 1280. E-mail: lynette.fairbanks@kcl.ac.uk, tony.marinaki@kcl.ac.uk

Treatment

In the UK there are two supra-regionally designated centres for the treatment of SCID and related disorders.

Consultants at either Centre are willing to discuss any children in whom there is any concern about possible immunodeficiency as follows:

Dr Bobby Gaspar, Senior Lecturer

Institute of Child Health and Great Ormond Street NHS. Trust, London, WC1N 3JH

Prof Andrew Cant

Hon Clin Prof Paediatric Immunology

Clinical Medical Sciences, University of Newcastle upon Tyne, NE2 4HH

Treatment with Carrier Erythrocyte Entrapped ADA is coordinated by

Dr Bridget Bax, Clinical Development Sciences, St. George's Hospital, Tooting.

Email: Dr Bridget Bax <bebax@sgul.ac.uk>

WEBSITES

The following websites are useful also as sources of further information:

SCID fact sheet. www.ich.ucl.ac.uk/factsheets/families/F000207

This is a website run by the unit at Great Ormond Street Hospital, and includes the text of the booklet referred to above

SCID homepage: www.scid.net

This has a detailed description of SCID and a number of links to related topics.

Online Mendelian Inheritance in Man (OMIM)

www.ncbi.nlm.nih.gov/entrez/query.fcgi?d=OMIM

A technical site with a detailed description of the inheritance of ADA deficiency, with links to SCID as well and to a large number of scientific papers.

The European Purine and Pyrimidine metabolism site

www.amg.gda/pl/~essppmm/ppd/ppd_pu_ada.html

Has another technical, biochemical and genetic description of ADA deficiency, but has not been updated to include recent information on (for example) gene therapy.

Other general sites:

<http://dragon.zoo.utoronto.ca/~jlm2001/JO1T0701E/background.html>

www.ncbi.nlm.nih.gov/disease/SCImn.html

Notes